

SINCE 1901

JEFFERSON UNION COMPANY

P.O. BOX 4420, DELAND, FLORIDA 32721-4420
369 W. MICHIGAN AVE., DELAND, FLORIDA 32720
386-626-6992 • FAX 386-626-6995 • INFO@JEFFERSONUNION.COM
TOLL FREE 888-462-5333 • WWW.JEFFERSONUNION.COM

LIST PRICE SHEET JU-2019

EFFECTIVE June 15, 2019

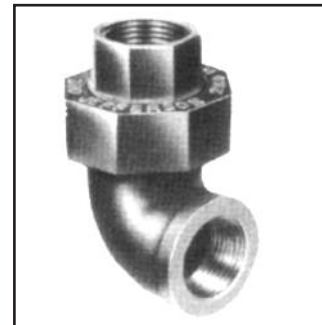
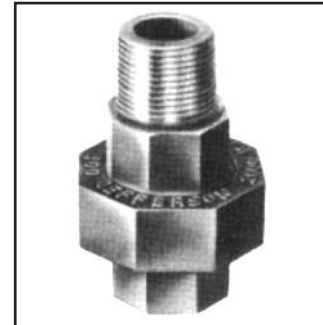
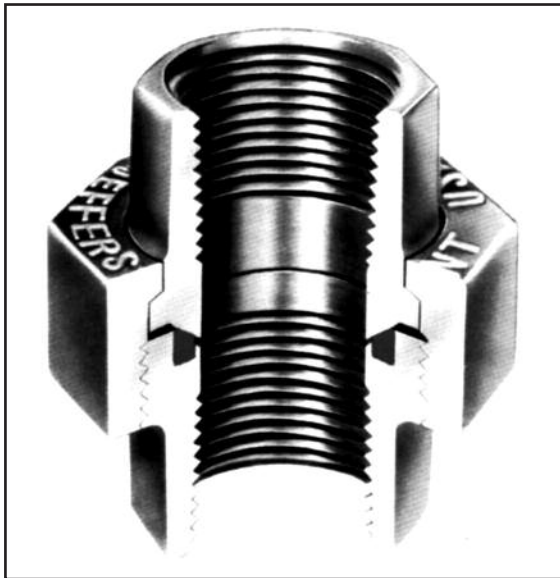

*The Standard
of Quality
for more than 110 Years...*

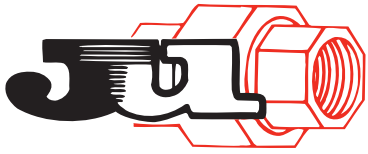

SINCE 1901

JEFFERSON UNION COMPANY





P.O. BOX 4420, DELAND, FLORIDA 32721-4420
 369 W. MICHIGAN AVE., DELAND, FLORIDA 32720
 386-626-6992 • FAX 386-626-6995 • INFO@JEFFERSONUNION.COM
 TOLL FREE 888-462-5333 • WWW.JEFFERSONUNION.COM

List Prices

150 POUND UNION

BRASS TO IRON - M2 - M4 - M6 - M8 - M10*

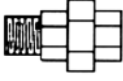
IRON TO IRON - M3 - M5* - M7*

| STYLES | | 1/2 | 3/4 | 1 | 1 1/4 | 1 1/2 | 2 | 2 1/2 | 3 |
|--|---------------------------------|-------|-------|-------|--------|--------|--------|--------|--------|
|  ALL FEMALE | M2 BLACK | 11.41 | 13.05 | 17.03 | 24.42 | 30.46 | 35.40 | 95.66 | 115.15 |
| | GALVANIZED | 14.27 | 17.00 | 21.46 | 31.02 | 37.74 | 43.23 | 136.15 | 190.58 |
|  ALL FEMALE | M3 (Iron to Iron Seat) BLACK | 16.01 | 18.16 | 23.53 | 32.41 | 39.62 | 49.99 | 132.40 | 159.28 |
| | GALVANIZED | 19.73 | 22.23 | 30.27 | 39.64 | 48.51 | 61.20 | 182.14 | 258.03 |
|  MALE & FEMALE | M4 BLACK | 16.29 | 22.41 | 31.47 | 43.31 | 51.05 | 68.22 | — | — |
| | GALVANIZED | 17.40 | 22.93 | 33.62 | 46.29 | 55.25 | 72.93 | — | — |
|  FEMALE ELBOW | M6 BLACK | 39.11 | 46.45 | 56.90 | 78.55 | 104.80 | 137.73 | — | — |
| | GALVANIZED | 51.36 | 61.78 | 77.64 | 106.03 | 140.86 | 196.96 | — | — |
|  MALE AND FEMALE ELBOW | M8 BLACK | 45.09 | 61.47 | 73.17 | 91.90 | 130.44 | 182.53 | — | — |
| | GALVANIZED | 58.91 | 80.29 | 95.57 | 134.41 | 181.63 | 238.52 | — | — |

TOLL FREE 888-462-5333

250 POUND

BRASS to IRON - X2 - X4 - X6 - X8 - X10

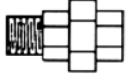
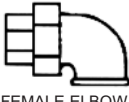
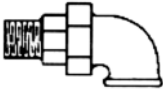

IRON to IRON - X3 - X5 - X7

| STYLES | | 1/4 | 3/8 | 1/2 | 3/4 | 1 | 1 1/4 | 1 1/2 | 2 | 2 1/2 | 3 |
|--|------------------|-------|-------|-------|-------|--------|--------|--------|--------|--------|--------|
|  ALL FEMALE | X2 - X3 BLACK | 17.27 | 17.27 | 15.60 | 17.80 | 21.87 | 35.28 | 42.16 | 46.47 | 139.66 | 148.59 |
| | GALVANIZED | — | — | 20.98 | 23.36 | 28.90 | 43.86 | 50.46 | 61.94 | 141.25 | 241.58 |
|  MALE & FEMALE | X4 - X5 BLACK | 28.58 | 28.58 | 20.45 | 27.51 | 34.21 | 45.81 | 56.63 | 75.37 | | |
| | GALVANIZED | 30.29 | 30.29 | 22.24 | 30.01 | 37.46 | 57.81 | 58.79 | 78.23 | — | — |
|  FEMALE ELBOW | X6 - X7 BLACK | — | — | 40.97 | 48.67 | 59.47 | 84.19 | 109.75 | 143.23 | — | — |
| | GALVANIZED | — | — | 53.77 | 66.50 | 81.62 | 110.95 | 147.37 | 204.70 | — | — |
|  MALE AND FEMALE ELBOW | X8 BLACK | — | — | 47.24 | 66.18 | 76.59 | 107.62 | 136.63 | 191.13 | — | — |
| | GALVANIZED | — | — | 60.47 | 82.54 | 100.26 | 139.21 | 175.76 | 242.45 | — | — |

300 POUND

BRASS TO IRON - J2 - J4 - J6

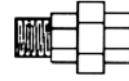
IRON TO IRON - J3

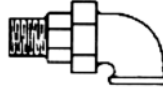
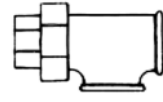
| STYLES | | 1/8 | 1/4 | 3/8 | 1/2 | 3/4 | 1 | 1 1/4 | 1 1/2 | 2 | 2 1/2 | 3 | 4 |
|--|-------------------------|-------|-------|-------|-------|-------|--------|-------|--------|--------|--------|--------|--------|
|  ALL FEMALE | J2 - J3 BLACK | 22.87 | 22.42 | 22.87 | 20.01 | 22.72 | 29.61 | 47.36 | 49.60 | 62.60 | 150.74 | 208.79 | 475.58 |
| | GALVANIZED | 30.83 | 27.50 | 28.03 | 27.85 | 30.26 | 40.05 | 55.87 | 67.26 | 83.78 | 185.07 | 304.87 | 586.19 |
|  MALE & FEMALE | J4 BLACK | — | 25.03 | 25.03 | 40.03 | 60.49 | 67.82 | — | — | — | — | — | — |
|  FEMALE ELBOW | J6 BLACK | — | — | 40.77 | 43.63 | 53.77 | 68.33 | 92.94 | 120.24 | 157.96 | — | — | — |
|  MALE AND FEMALE ELBOW | J8 BLACK | — | — | — | 49.40 | 69.19 | 80.07 | — | — | — | — | — | — |
| | GALVANIZED | — | — | — | 62.22 | 86.31 | 104.82 | — | — | — | — | — | — |
|  FEMALE TEE UNION ON RUN | J10 BLACK | — | — | — | 42.54 | 50.68 | 61.38 | 78.78 | 102.34 | 140.20 | — | — | — |
| | GALVANIZED (on request) | — | — | — | — | — | — | — | — | — | — | — | — |

SHIPMENT OF ALL ORDERS ON ABOVE STOCK ITEMS CAN BE MADE SAME DAY ORDER IS RECEIVED.

OUR 24 HOUR FAX NUMBER (386) 626-6995

Packaging

Standard Packaging Quantities and Estimated Weights (Cartons)

| 150# & 250# ALL FEMALE | | | | | | | | | | | |
|-------------------------------------|------------|------------|------------|--------------|--------------|----------|--------------|--------------|----------|--------------|----------|
| SIZE | 1/2 | 3/4 | 1 | 1 1/4 | 1 1/2 | 2 | 2 1/2 | 3 | | | |
| PIECES | 50 | 50 | 25 | 25 | 20 | 15 | 8 | 4 | | | |
| POUNDS | 22 | 34 | 24 | 38 | 37 | 43 | 28 | 27 | | | |
| 150# & 250# ALL FEMALE UNION ELBOWS | | | | | | | | | | | |
| SIZE | 1/2 | 3/4 | 1 | 1 1/4 | 1 1/2 | 2 | | | | | |
| PIECES | 50 | 50 | 30 | 20 | 15 | 8 | | | | | |
| POUNDS | 28 | 39 | 40 | 41 | 41 | 31 | | | | | |
| 300# ALL FEMALE | | | | | | | | | | | |
| SIZE | 1/8 | 1/4 | 3/8 | 1/2 | 3/4 | 1 | 1 1/4 | 1 1/2 | 2 | 2 1/2 | 3 |
| PIECES | 100 | 100 | 100 | 60 | 50 | 25 | 20 | 15 | 10 | 8 | 4 |
| POUNDS | 19 | 28 | 38 | 35 | 42 | 33 | 43 | 42 | 44 | 50 | 34 |
| 300# ALL FEMALE UNION ELBOWS | | | | | | | | | | | |
| SIZE | | | 3/8 | 1/2 | 3/4 | 1 | 1 1/4 | 1 1/2 | 2 | | |
| PIECES | | | 50 | 40 | 30 | 20 | 15 | 10 | 6 | | |
| POUNDS | | | 22 | 30 | 30 | 35 | 38 | 37 | 30 | | |

JEFFERSON UNION - TERMS AND CONDITIONS

2% Cash Discount 10 days - net 30 days. Freight Charges prepaid and allowed on 500 lbs. or more. No responsibility can be assumed for losses, damages or delays caused by fires, strikes or contingencies beyond our control. When ordering, always give the Figure Number as shown in the catalog. Black will be shipped unless Galvanized is specified. J-Series Unions will be shipped on orders for 300 pound Unions unless otherwise specified. Orders for Engineered Specialties are not subject to cancellation after manufacture of the material has been started. We guarantee all Jefferson products to the extent that we will replace any Unions having manufacturing defects. We cannot make allowances or be responsible for labor or expense required to repair defective goods. Our responsibility in all cases is limited to the price of the defective material. When goods are delivered to carrier in good order, the carrier becomes responsible for losses or damage in transit. No claim will be allowed unless made within ten days of receipt of shipment.

Manufacturers of Malleable Iron Pipe Unions and Union Fittings Since 1901